

US - 29219 KPP

Sipariş Kodu: 3105-227

US
AIR SPRING

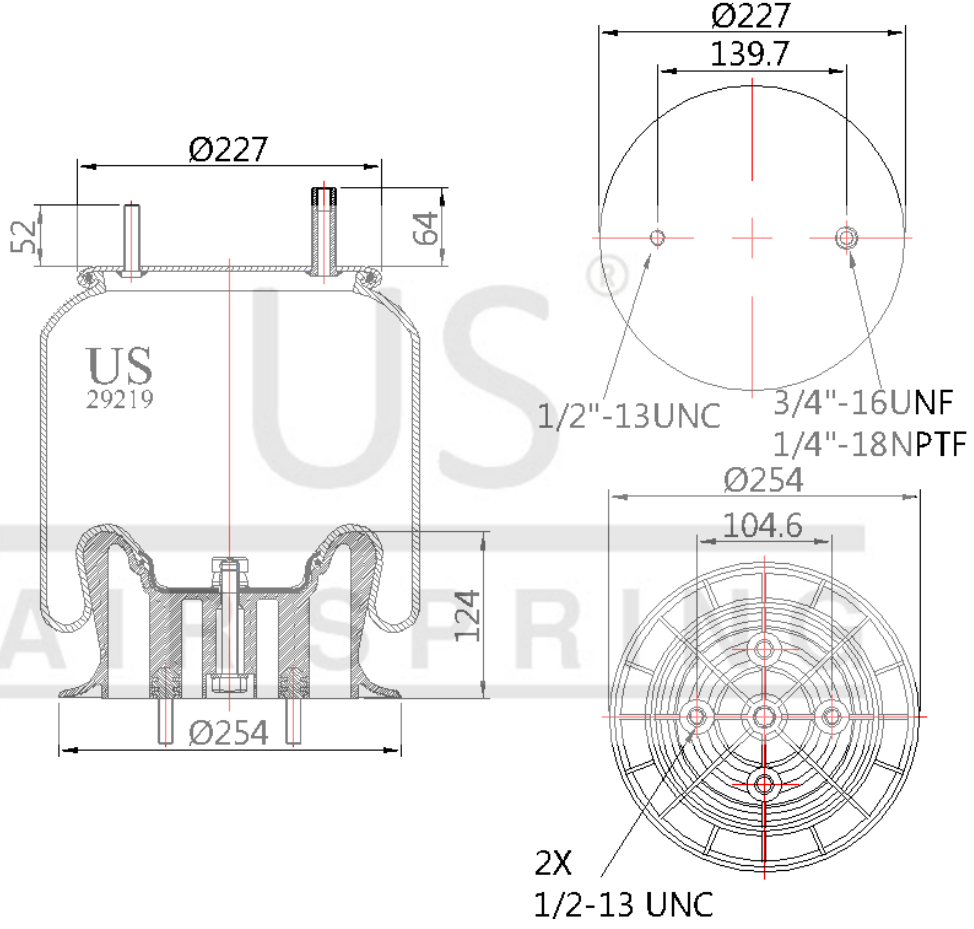

© 2025 US AIR SPRING. ALL RIGHTS RESERVED. <http://www.usmerkaucuk.com/>

Ürün Özellikleri

Ürün Tipi	KPP
Ürün Kodu	29219 KPP
Sipariş Kodu	3105-227
Kutu Boyutu	780*1180*560
Kutudaki Adet	20 PCS
Ağırlık	6,3 Kg.
Tork	
Ürün Grubu	

US - 29219 KPP

Sipariş Kodu: 3105-227



CROSS Kodları

CONTITECH	91016P408
FIRESTONE	1T15M6
FIRESTONE	W013589219
GOODYEAR	1R12151
GOODYEAR	1R12182
GOODYEAR	566243038
TAURUS	6363
TRIANGLE	AS8408
FLEETPRIDE	AS9219
TRP	AS92190
AUTOMANN	1DK23K9219

OEM Kodları

SAF HOLLAND	57009219
LOADGUARD	SC2070
NAVISTAR	1681739C1
NAVISTAR	1672401C1
RIDEWELL	1003589219C
VOLVO	3522233203
VOLVO	350033201
VOLVO	350033203
VOLVO	350033204
VOLVO	350033209